



CA10289

MPPT HYBRID SOLAR INVERTER

YOHAKO

USER MANUAL



JAPAN TECHNOLOGY

Trademarks

Other trademarks, registered trademarks, and product names are the property of their respective owners and are used herein for identification purposes only.

Exclusion for Documentation

- (A) Makes no warranty as to the accuracy, sufficiency or suitability of any technical or other information provided in its manual or other documentation.
- (B) Assumes no responsibility or liability for losses, damages, cost or expenses, whether special, direct, indirect, consequential or incidental, which might arise out of the use of such information. The use of such information will be entirely at the user's risk.

TABLE OF CONTENT

1. Important Safely Instructions.....	1
2. Description.....	3
3. Operation.....	5
4. Installation.....	10
5. Troubleshooting.....	17
6. Installation.....	17
7. Technical Data.....	19
8. Warranty scope.....	20
Appendix.....	21

1. IMPORTANT SAFETY INSTRUCTIONS

SAFETY INSTRUCTIONS

1.1 General

Please familiarize yourself with the safety features and instructions by first reading the documentation supplied with this product before using the equipment. This product has been designed and tested in accordance with international standards. The equipment must be used exclusively for the purpose for which it was designed.



The product is used in conjunction with a permanent energy source (battery). Input and/or output terminals may still be dangerously energized, even when the equipment is switched off. Always switch off the AC supply and the battery before carrying out maintenance or servicing the product.

The product has no internal user-serviceable components. Do not remove the front plate or operate the product if any panels have been removed. Only Qualified personnel must undertake all servicing.

Never use the product in around where there is a risk of gas or dust explosions. (before using) Consult the battery manufacturer's to confirm the products if can be used with the battery. Always comply with the battery manufacturer's safety instructions.

1.2 Installation

Read the installation instructions in the installation manual before installing the equipment.

This is a Safety Class I product (supplied with a protective grounding terminal). Uninterruptible protective grounding must be provided at the AC input and/or output terminals. Alternatively the grounding point

located externally on the product may be used. Whenever it is likely that the grounding protection has been damaged, the product must be turned off and secured against unintended operation.

Ensure that the DC and AC input cables are fused and fitted with circuit breakers. Never replace a safety component with a different type. Always consult the manual to determine the correct component.

Before applying power, ensure that the available power source matches the required specification of the product as described in the manual.

Ensure that the equipment is used under the correct ambient conditions. Never operate the product in a wet or dusty environment. Ensure there is adequate free space for ventilation around the product and check that the ventilation vents are not blocked.

Ensure that the required system voltage does not exceed the product's capacity.

1.3 Transport and Storage

Ensure that the mains power and battery leads have been disconnected before storing or transporting the product.

No liability can be accepted for any transport damage if the equipment is shipped in non-original packaging.

Store the product in a dry environment; the storage temperature must be between -20°C and 60°C.

Consult the battery manufacturer's manual in respect of transport, storage, charging, recharging and disposal of the battery.

2. DESCRIPTION

Fig 1: Inverter

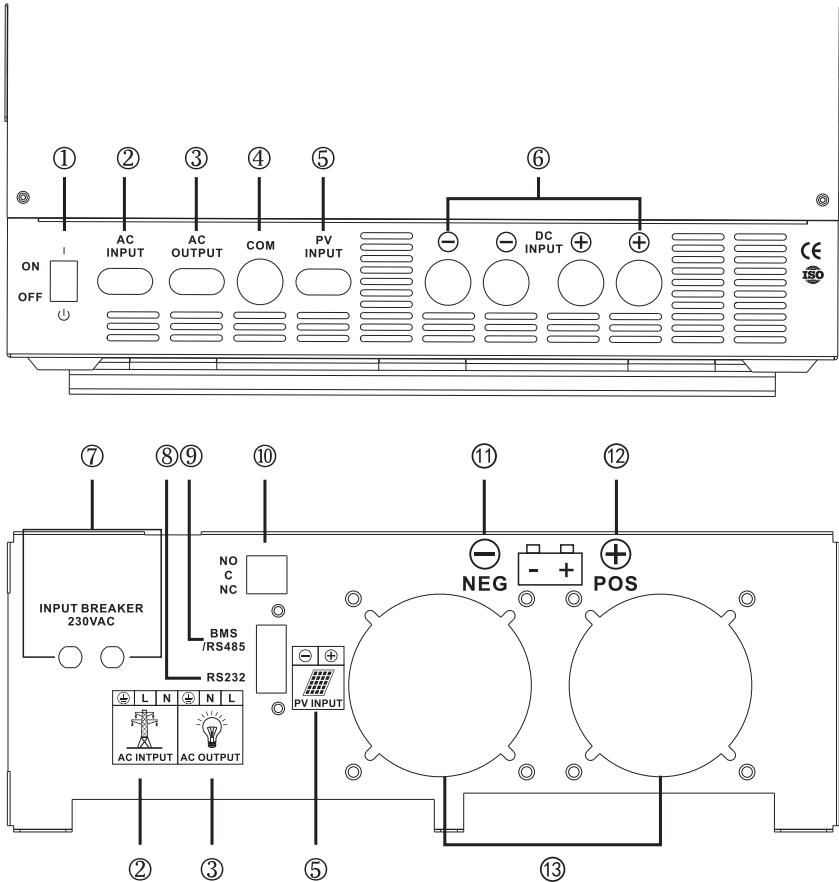

- 1.....Power on/ off switch
- 2.....AC input
- 3.....AC output
- 4.....Communication port
- 5.....PV input
- 6.....Battery input
- 7.....Input breaker

- 8.....RS232 communication port
- 9.....BMS/RS485 communication port
- 10...Dry contact
- 11...Battery terminal negative
- 12...Battery terminal positive
- 13...Fan

Fig 2: LCD Screen

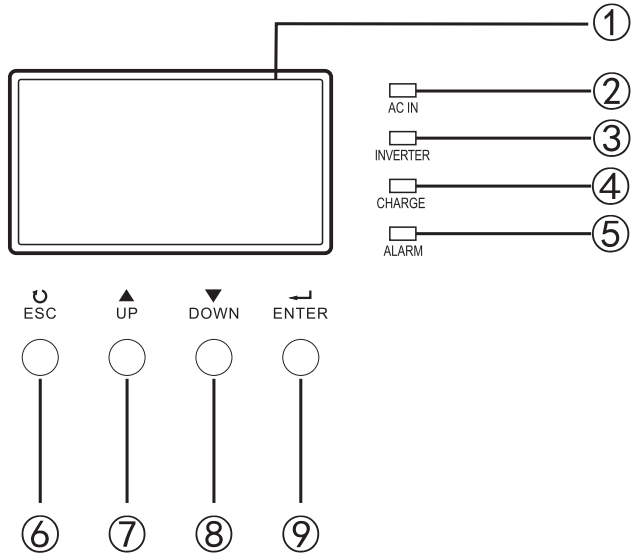

- | | |
|-------------------------|----------------------|
| 1..... Indicator Screen | 6..... Escape Key |
| 2..... AC In LED | 7..... Page UP Key |
| 3..... Inverter LED | 8..... Page Down Key |
| 4..... Charge LED | 9..... Confirm Key |
| 5..... Alarm LED | |

Fig 3: Power Button

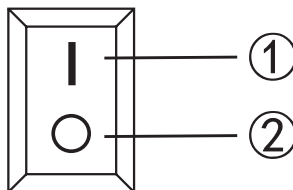

- | |
|----------------|
| 1.....On Mode |
| 2.....Off Mode |

3. OPERATION

3.1 AC In

When power button is switched to “on”, the product is fully functional. The inverter will come into operation and the green LED “AC In” will light up.

3.2 Inverter Mode

In the event of a grid failure, or generator power being disconnected, the unit switches to inverter mode and takes over supply to the connected loads. This happens so fast (less than 10 milliseconds) that computers and other electronic equipment will continue to operate without disruption. The green LED light of “Inverter” indicates on the LCD panel

3.3 Charging Mode

In the event of restoration of grid, or generator power, the Inverter commences charging. The “AC In” green LED light comes up, and the orange “Charge” light starts blinking. When the batteries are fully charged, the blinking orange light changes to Solid Orange.

3.4 Alarm Mode

In the event of high battery discharge, and its gets close to the battery cutoff level, the red “Alarm” light starts showing, and it is accompanied with a beeping sound, this continues until the units gets to the battery voltage cutoff level and its powers down automatically, except there is a restoration of grid supply in which case it changes back to charging mode.

3.5 Bypass Functionality:

When the power control button is switched to “**OFF**”, and there is a grid or generator supply, the inverter supplies output to the load and also charges.

When the power control button is switched to “**OFF**”, and there is no grid or generator supply, the inverter supplies does not supply output to the load.

3.6 Setting Mode

Quick setting mode

Long press the "ENTER" button for 5S, and then release the button. The display automatically enters the setting interface "Quick Setting", select the parameters through the "UP" and "DOWN" buttons, and then press the "ENTER" button to lock the parameters in the setting item interface that needs to be changed, and then press the "UP" and "DOWN" buttons is used for setting. After the setting is completed, press the "ENTER" button again, the screen will prompt whether the setting is successful.

Settable items	Parameters	Descriptions
Beep Status Buzzer mode	ENABLE	Allows beeping in fault state
	DISABLE	No beeping in any state
Backlight Type Backlight mode	ON	The display backlight is always on
	OFF	The display backlight is always off
	DELAY	Display backlight smart switch

Advanced setting mode

Press the button "ESC" and "ENTER" together and then release them. It will be in setup mode when the screen shows "Password: 00000". The password is 12345, press the button "UP" or "DOWN" to enter the password. After password entering choose the option "Yes" and press the button "ENTER" so as to confirm the password.

After confirming the password, enter the setting interface "Advanced Setting", use the "UP" and "DOWN" buttons to select parameters, and then press the "ENTER" button to lock the parameters in the setting item interface that needs to be changed, and then press "UP" and the "DOWN" buttons to set. After the setting is completed, press the "ENTER" button again, the screen will prompt whether the setting is successful.

Settable items	Parameters	Descriptions
AcV Range Type Input range	NARROW	Mains input range is 180~265V
	WIDE	Mains input range is 155~265V
AcF Range Type Input frequency range	NARROW	Mains input frequency range is 45~65HZ
	WIDE	Mains input frequency range is 40~70HZ
Work Mode Type Charging priority	Utility First	The utility power will provide power to the load first. Only when the utility power is not enough to supply the load, the solar energy And the battery will provide power to the load.
	Solar First	When solar energy is sufficient, solar energy will be preferentially provided to the load. When there is solar energy but not enough, the solar energy and battery power will provide power to the load at the same time. When there is no solar power, the utility will provide power to the load. At the same time, If the battery voltage drops to the low-battery warning voltage point or the set DC-to-AC voltage point, the mains will also provide power to the load.
	Dc First	When solar energy is sufficient, solar energy will be preferentially provided to the load. When there is solar energy but not enough, the solar energy and battery power will provide power to the load at the same time. If the battery voltage drops to the low battery warning voltage point or the set DC to AC voltage point, the mains will provide power to the load.
Charge Mode Type	Utility First	The energy of the mains and the solar energy charge the battery at the same time.
	Solar First	In the solar priority mode, when the PV meets the requirements, the battery is charged with solar energy preferentially, and when the battery voltage is too low, the mains charge will be started.
	Solar Only	The machine simply uses the energy of solar energy to charge the battery.
AcCha Percent Mains charging curren	0~100%	Adjustable charging current ratio of mains
SolCha Percen Solar charging	0~100%	You can adjust the charging current proportional solar
Bulk Cha Vol Bulk charging voltage setting	13.5~15V	Bulk charging voltage setting, according to different types of batteries
	27~30V	
	54~60V	
Float Cha Vol Float voltage setting	12.5~14V	Float voltage setting, according to different types of batteries
	25~28V	
	50~56V	

BatLowLock Vol Shutdown voltage	9.5~11.5V	Set the shutdown voltage point of battery protection voltage
	19~23V	
	38~46V	
SolarToAc Vol Return to the mains charging voltage point	11.5~12.5V	Set the battery voltage point when the mains power is involved in the solar energy priority charging mode
	23~25V	
	46~50V	
Ac To Dc Voltage	13~14V	Select the voltage point of converting from mains to solar power in solar priority mode
	27~28V	
	54~56V	
Inv Output Vol Output voltage	200~240V	Set the inverter output voltage
AcC Speed Type Mains sensitivity	HIGH	Mains sensitivity settings: high medium low
	MID	
	LOW	
Inv Fre Type Output frequency	50/60HZ	Set inverter output frequency
Restart Allow Restart	ALLOW	Restart 3 times after short circuit or overload
	NOT ALLOW	No restart after short circuit or overload
Backlight Type Backlight mode	ON	The display backlight is always on
	OFF	The display backlight is always off
	DELAY	Display backlight smart switch
Beep Status Buzzer mode	ENABLE	Allows beeping in fault state
	DISABLE	No beeping in any state
Bat Cap Limit	ON	Intelligent battery protection function, it is not recommended to change
	OFF	
Load Limit	ON	Intelligent transformer temperature protection function, it is not recommended to change
	OFF	
Load Offline Warn	ON	This setting does not adapt to this inverter. Setting not available.
	OFF	
Outside Uart Baud	2400	Set the communication baud rate
	4800	
	9600	
Output Mode	220	Set display output voltage
	110	
Swon Bat Voltage	10.5~12.2V	After the machine is shut down abnormally, the battery voltage must be higher than the set value before it can be turned on normally
	21~24.4V	
	42~48.8V	
Low Off Restart Vol	12~14V	After the machine is powered off at low power, the battery voltage is higher than the set value and it can be automatically turned on
	24~28V	
	48~56V	

Battery Type	SEL	Sealed Lead Acid Battery
	GEL	Gel Battery
	FLD	Inter Cell
	USER	Customer Customization
	LiCoMnNiO2	Ternary Lithium Battery
	BAT-LiFePO4	Lithium Iron Phosphate Battery
Factory Reset	YES	All settings are restored to factory settings
	NO	No recovery process, keep existing settings
BMS Function Switch	On	Whether to enable the BMS communication function
	Off	
Bat Soc Under Lock	5~50%	BMS low voltage SOC value, if the BMS SOC value is lower than the set value, the inverter will shut down to protect the battery
Bat Soc Turn To Ac	5~50%	When the working mode of the inverter is set to the battery priority mode, the inverter will be forced to enter the mains charging when the SOC of the BMS is lower than the set value.
Bat Soc Turn To Dc	50~100%	When the working mode of the inverter is set to the battery priority mode, the inverter resumes the DC working mode when the SOC of the BMS is higher than the set value.
Bat Restart Soc	30~100%	When the inverter is turned on, the SOC must be higher than the set value to work normally.
Factory Reset	On	All settings are restored to factory settings
	Off	No recovery process, keep existing settings
ECO Mode	On	ECO mode switching
	Off	

When the BMS/485 communication interface is externally connected, as shown in the following figure:

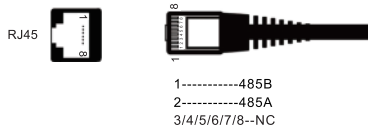

Communication Connection

Please use supplied communication cable to connect to inverter and PC. Please install a monitoring software on the computer.

Dry Contact Signal

There is one dry contact (3A/250VAC) available on the rear panel. It could be used to deliver signal to external device when battery voltage reaches warning level.

Unit Status	Condition		Dry contact port: 		
			NC & C	NO & C	
Power Off	Unit is off and no output is powered.		Close	Open	
Power On	Output is powered from battery or solar.	Normal mode	Battery voltage < Low DC warning voltage	Open	Close
			Battery voltage > Float charging voltage	Close	Open
		Solar first mode	Battery voltage < Solar to AC voltage	Open	Close
			Battery voltage > AC to DC voltage	Close	Open

4. INSTALLATION



4.1 Locating and Mounting the Inverter

The product must be installed in a dry and well-ventilated area, as close as possible to the batteries. There should be a clear space of at least 10cm around the appliance for cooling.

Excessively high ambient temperature will result in the following:

- Reduced service life.
- Reduced charging current.
- Reduced peak capacity, or shutdown of the inverter.

Never mount the appliance directly above the batteries.

The product is suitable for wall mounting. For mounting see Fig.1.

The appliance can be mounted horizontally as well as vertically; vertical mounting is preferable. The vertical position offers optimum cooling.

The interior of the product must remain accessible after installation.

Try and keep the distance between the product and the battery to a minimum in order to minimize cable voltage losses.

For safety purposes, this product should be installed in a heat-resistant environment if it is used with equipment where a substantial amount of power is to be converted. You should prevent the presence of e.g. chemicals, synthetic components, curtains or other textiles, etc., in the immediate vicinity.

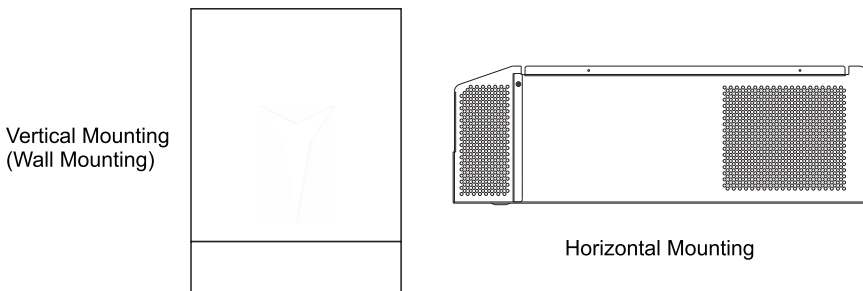

Approved orientations for inverter mounting.

4.2 AC Wiring

This is a Safety Class I product (supplied with a protective grounding terminal). **Uninterruptible protective grounding must be provided at the AC input and/or output terminals and/or chassis grounding point located externally on the product.**

AC Wiring should be connected in the following order:

- AC INPUT (Source)
- AC OUTPUT (Load)

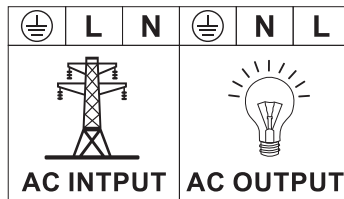

Fig 4:AC input/Output Connections

AC Input: The inverter comes installed with Input protection circuit breaker.This should be switched off before the cable is installed.

Remove the AC wiring compartment cover to gain access to the AC terminal strip inside.

Run the three conductors AC INPUT (source) wiring into the wiring compartment.Connect the AC INPUT ground wire first to the ground terminal (ground symbol with circle around it),and then connect the AC INPUT line (L) and neutral wire (N) to the corresponding AC input terminals.

AC Output: The inverter comes installed with Input protection circuit breaker.This should be switched off before the cable is installed. In a similar manner,connect the AC OUTPUT (load) wiring to the Inverter AC output terminal as was done on the AC Input

After wiring ,double check and review all connections to make sure the wires are in the correct terminals and the terminals are tight

To ensure the best performance from your inverter system,do not use old or untested batteries.Batteries should be of the same size,type, rating,and age.

AC Safety Grounding: During the AC wiring installation,AC input and output ground wires are connected to the inverter.The AC input ground wire must connect to the incoming ground from your AC utility source. The AC output ground wire should go to the grounding point for your loads (e.g.a distribution panel ground bus).

4.3 DC Wiring:

 WARNING
<p>DO NOT connect the DC wires from the battery bank to the inverter until:</p> <ul style="list-style-type: none">● All AC wiring is complete,● The correct DC and AC protection switches are OFF● The correct DC voltage and polarity have been verified

Depending upon the type of batteries you use in the installation (6 or 12 VDC),the batteries must be wired in series,parallel,or series-parallel. The interconnecting DC wires must be sized and rated exactly the same as those that are used between the battery bank and the inverter.

To ensure the best performance from your inverter system,do not use old or untested batteries.Batteries should be of the same size,type, rating,and age.

4.3.1 procedure

In order to fully utilize the full capacity of the product,batteries with sufficient capacity and battery cables with sufficient cross section should be used.

Proceed as follows to connect the battery cables:

 WARNING
<ul style="list-style-type: none">● Use an insulated box spanner in order to avoid shorting the battery.● Avoid shorting the battery cables.

Connect the battery cables: the + (red) on the left and the-(black) on the right,to the battery.Reverse polarity connection (+ to - and - to +) will cause damage to the product.(Safety fuse inside the Inverter unit can be damaged)

The DC overcurrent device (i.e.,fuse or circuit breaker) must be placed in the positive (RED) DC cable line between the inverter's positive DC terminal and the battery's positive terminal (RED);as close to the battery as possible.

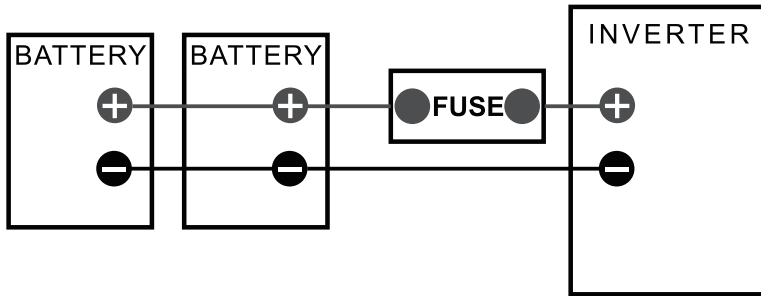

Fig 5:Inline fuse

A brief spark or arc may occur when connecting the battery cables to the inverter DC terminals;this is normal and due to the inverter's internal capacitors being charged.

All wiring to the battery terminals should be checked periodically (once a month) for proper tightening

Secure the nuts tightly in order to reduce the contact resistance as much as possible.

Be aware that over-tightening or misthreading the nuts on the DC terminals can cause the bolts to strip and snap/break off.

4.3.2 DC Wiring Size

It is important to use the correct sized DC wire to achieve maximum efficiency from the system and to reduce fire hazards associated with overheating.Always keep your wire runs as short as practical to prevent low voltage shutdowns and to keep the DC breaker from nuisance tripping (or open fuses) because of increased current draw.

The correct minimum DC wiresize (and corresponding overcurrent device) is required in order to reduce stress on the inverter,minimize voltage drops,increase system efficiency and ensure the inverter's ability to surge heavy loads.

If the distance from the inverter to the battery bank is ≤ 5 feet,use a minimum DC wire size of #2 AWG (33.6 mm²).If the distance between the inverter and the battery is >5 feet,the DC wire will need to be increased.Longer distances cause an increase in resistance,which affects the performance of the inverter.

Tab.I

Models	Minimum DC Wire Size(rating)	Maximum DC Fuse size	DC Grounding wire size
5524/48	50/25mm ²	250/160A	2.5mm ²
6048	25mm ²	150A	4.0mm ²
8048	35mm ²	200A	4.0mm ²
10048	50mm ²	250A	4.0mm ²
12548	60mm ²	300A	4.0mm ²

4.3.3 Parallel and Series Connection

12 Volts Battery In Parallel

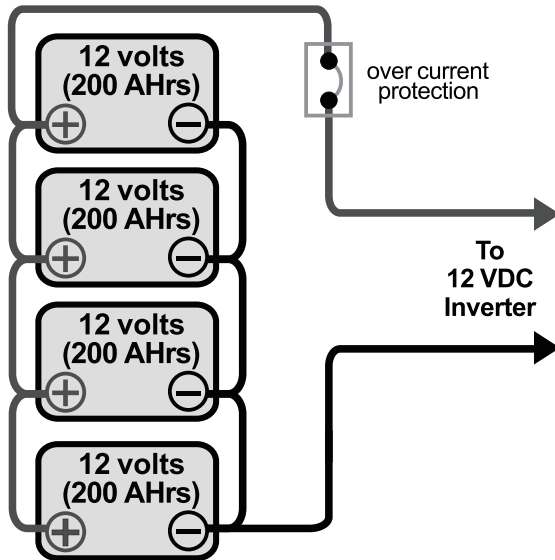

12 volt battery (total capacity=800 Ah)

Fig 6. Parallel Battery Wiring

12 volts Battery in Series

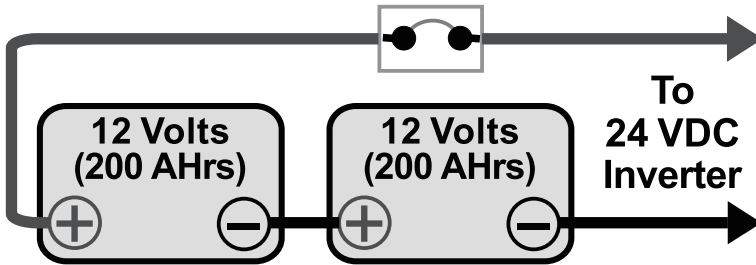

24 Volts battery (total capacity=200 Ah)

Fig 7. Parallel Battery Wiring

Difference between Series and Parallel connection

Batteries in Parallel

Voltage remain the same
Ah capacity doubles

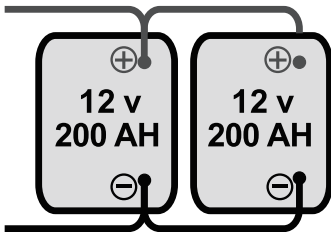

System Voltage = 12Volts
Ah Capacity = 400AH

Batteries in Series

Voltage doubles
Ah capacity stays the same

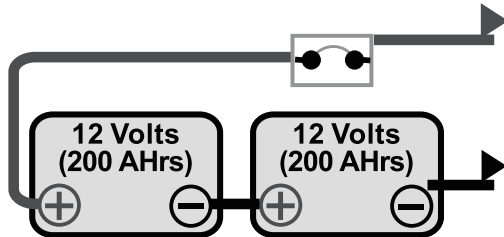

System Voltage=24V
Ah Capacity=200AH

Tab.II

Models	DC Rating (Volts)	Minimum Batteries	Maximum Batteries
5524/48	24/48V	2/4	6/8
6048	48	4	8
8048	48	4	12
10048	48	4	16
12548	48	4	16

5. TROUBLESHOOTING

Proceed as follows for quick detection of common faults. DC loads must be disconnected from the batteries and the AC loads must be disconnected from the inverter before the inverter and/or battery charger is tested.

Consult your local dealer/repair center if the fault cannot be resolved.

Tab.III

Problem	Cause	Solution
The inverter fails to operate when switched on	Battery terminal not firm	Tighten the battery terminals.
Continuous spark from the inverter terminal	Battery terminal reversal	Check and connect the cable to the right terminal lead.
No output from inverter	Output cable terminals loosed	Open the casing and connect the output cable terminals firm to the appropriate lead.
Inverter not charging battery	input power less than(<) 150/83~96VAC	A step-up stabilizer of rating higher than the inverter should be installed.
Continuous alarm when the inverter is loaded	Overloading condition	Check the loads and disconnect heavier loads.

6. INSTALLATION

Unpacking and Inspection

Before installation, please inspect the unit. Be sure that nothing inside the package is damaged. You should have received the following items inside of package:

- The unit×1
- User manual × 1
- Communication cable × 1

Preparation

Before connecting all wirings, please take off bottom cover by removing four screws as shown below.

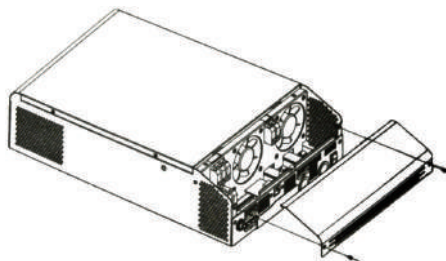

Mounting the Unit

Consider the following points before selecting where to install:

- Do not mount the inverter on flammable construction materials.
 - Mount on a solid surface
 - Install this inverter at eye level in order to allow the LCD display to be read at all times.
 - For proper air circulation to dissipate heat, allow a clearance of approx. 20cm to the side and approx. 50cm above and below the unit.
 - The ambient temperature should be between 0°C and 55°C to ensure optimal operation.
- The recommended installation position is to be adhered to the wall vertically
- Be sure to keep other objects and surfaces as shown in the diagram to guarantee sufficient heat dissipation and to have enough space for removing wires.

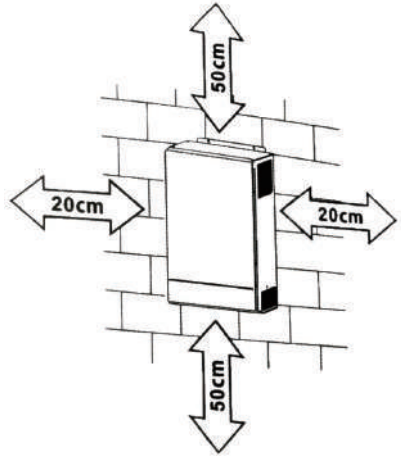

SUITABLE FOR MOUNTING ON CONCRETE OR OTHER NON-COMBUSTIBLE SURFACE ONLY.

Install the unit by screwing three screws.

- The hanging brackets 1, 2, and 3 are fixed on the wall with M6*80mm expansion screws.
- The hook on the back of the Inverter is aligned with the hanging bracket hole.

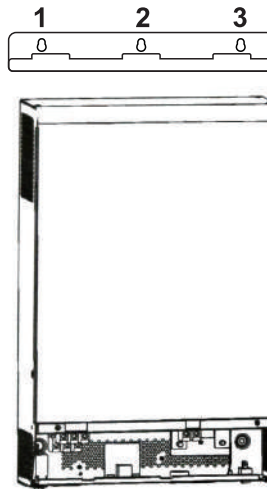

Battery Connection

CAUTION: For safety operation and regulation compliance, it's requested to install a separate DC over-current protector or disconnect device between battery and inverter. It may not be requested to have a disconnect device in some applications, however, it's still requested to over-current protection installed. Please refer to typical amperage in below table as required fuse or breaker size.

7. TECHNICAL DATASHEET

MODEL	5524/48	6048	8048	10048	12548
Input					
Capacity (VA)	5500VA	6000VA	8000VA	10000VA	12500VA
Voltage (DC)	24/48V	48V	48V	48V	48V
Nominal Voltage	220VAC/110VAC				
Voltage Range	154-264VAC/77-132VAC				
Frequency	50-60Hz Auto sensing				
Output					
Watt	4400W	4800W	6400W	8000W	10000W
Voltage	220VAC/110VAC				
Frequency	50/60Hz				
Waveform	Pure sinewave				
Transfer time(AC to DC)	<8ms				
Transfer time(DC to AC)	<8ms				
Output voltage regulation	10%rms				
Bypass Mode	Yes				
Saver Mode	Yes				
Efficiency	>98%				
Protection					
Input Protection	Circuit Breaker				
Output Protection	Circuit Breaker				
Battery					
Battery Type	AGM-Deep Cycle,GEL				
	Up to 500Ah				
Charging current	48/24A	29A	39A	50A	60A
Low Level disconnect(Selectable)	24V:(20V or 21V) 48V:(40V or 42V)				
LCD Indicator status	Input AC,Output AC				
	Battery DC,Output Load				
	Alarm,Fault				
	Battery Charge Level				
LED Indicator status	Output Frequency				
	AC Line In:Green				
	Inverter:Green				
	Charging:Yellow				
Battery low alarm	Alarm:Red				
	24V:battery light discharge 23V; battery load discharge 23V@load<20% ; 22V@load>50%/21V@load>50%; 48V:battery light discharge 46V; battery load discharge 46V@load<20% ; 44V@load>50%/42V@load>50%;				
Battery low recovery	24V:battery light discharge 24V ; battery load discharge 24V@load<20% ; 23V@load>50%/22V@load>50%; 48V:battery light discharge 48V ; battery load discharge 48V@load<20% ; 46V@load>50%/44V@load>50%;				
DC low voltage shutdown	24V:battery light discharge 22V ; battery load discharge 22V@load<20% ; 21V@load>50%/20V@load>50%; 48 V:battery light discharge 44V ; battery load discharge 44V@load<20% ; 42V@load>50%/40V@load>50%;				
DC high voltage alarm and fault	31.2V/62.4V				
DC high voltage recovery	30V/60V				

Maximum PV array power	24V:2110W 48V:4220W	
MPPT/PWM input voltage range	24V:MPPT30-200VDC(or PWM30VDC-105VDC) 48V:MPPT60-200VDC(or PWM60VDC-105VDC)	
Maximum PV array open circuit voltage	24V:MPPT200VDC(or PWM105VDC) 48V:MPPT200VDC(or PWM105VDC)	
Maximum solar charging current	80A	100A
Alarm		
Low battery alarm	Audible alarm-1 beeping per second	
Overload alarm	Audible alarm-continuous beeping	
Fault	Audible alarm-continuous beeping	
Environment		
Temperature	-10~50°C	
Humidity	C0-95 %, Non condensing	
Acoustic Noise(db)	<45dB	

8. WARRANTY SCOPE:

The following is not within the scope of warranty:

- (a) Battery configured by user.
- (b) Do not operate according to the user's manual, resulting in damage to the machine.
- (c) Mechanical damage due to natural disasters such as fire, flood, etc.
- (d) Products beyond the warranty period, the implementation of paid maintenance services

Appendix

How to choose and configure PV panels

The following parameters can be found in the specifications of each PV panel:

- Pmax: Maximum output power (W)
- Voc: Open circuit voltage (V)
- Isc: Short circuit current (A)
- Vpm: Rated voltage (V)
- Ipm: Rated current (A)

PV panels can be connected in series or in parallel to obtain the required output voltage and current to meet the allowable range of the solar controller.

When connecting PV panels in series, the total maximum voltage and current are:

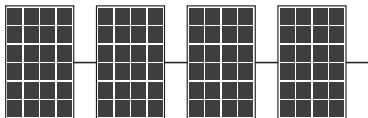

$$V_{\text{string}} = V_1 + V_2 + V_3 + V_4 \dots$$

$$I_{\text{string}} = I_1 = I_2 = I_3 = I_4 \dots$$

When the PV panels that have been connected in series are connected in parallel, the total maximum voltage and current are:

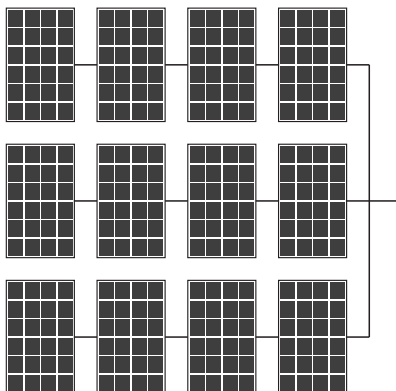

$$V_{\text{total}} = V_{\text{string1}} = V_{\text{string2}} = V_{\text{string3}} = V_{\text{string4}} \dots$$

$$I_{\text{total}} = I_{\text{string1}} + I_{\text{string2}} + I_{\text{string3}} + I_{\text{string4}} \dots$$

- In either case, the total output power is the power of a single PV panel \times the total number of PV panels. The criteria for configuring PV panels is that the total power should be equal to or slightly greater than the maximum allowable PV power of the solar controller (please refer to the technical parameter table). The excess capacity of PV panels does not contribute to the capacity of solar chargers and will only lead to higher installation costs.
- The total Ipm of the PV panels should be less than the maximum charging current of the inverter (80A) .
- The total Voc of the PV panel should be less than the maximum PV input voltage of the inverter (please refer to the technical parameter table).

Example 1: Take the 48 V inverter as an example to select the appropriate PV module. Consider that the total Voc of the PV panel cannot exceed the maximum (PWM controller 105 V / MPPT controller 200V) . The total power should be equal to or slightly greater than 6100W , we can choose the following specifications of PV panels.

Maximum power (Pmax)	80W	The number of PV panels connected in series for each group: PWM→4 PCS (4*21.6V<105V) MPPT→6 PCS (6*21.6V<150V) Total number of PV panels: 76PCS→6100W/80W= 76 (PCS) Number of groups that can be connected in parallel: PWM→19groups (76/4 = 19 groups) MPPT →12groups (76/6 =12groups)
Rated voltage Vpm(V)	18V	
Rated current Ipm(A)	4.46A	
Open circuit voltage Voc(V)	21.6V	
Short circuit current Isc(A)	4.8A	

The configuration scheme of the 48V inverter is:

PWM controller: Every 4 PV panels are connected in series into one group, and 19 groups of PV panels are connected .

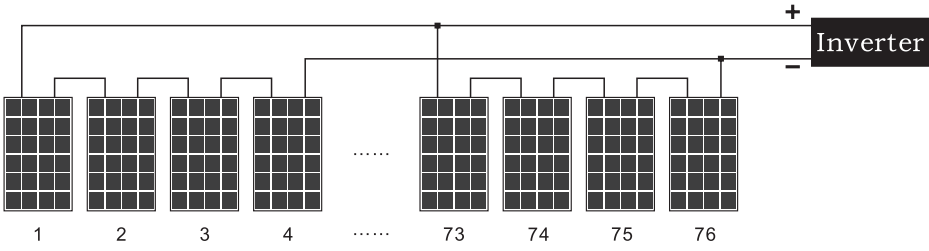

MPPT controller: Every 6 PV panels are connected in series into one group, and 12 groups of PV panels are connected (it can be connected same as PWM).

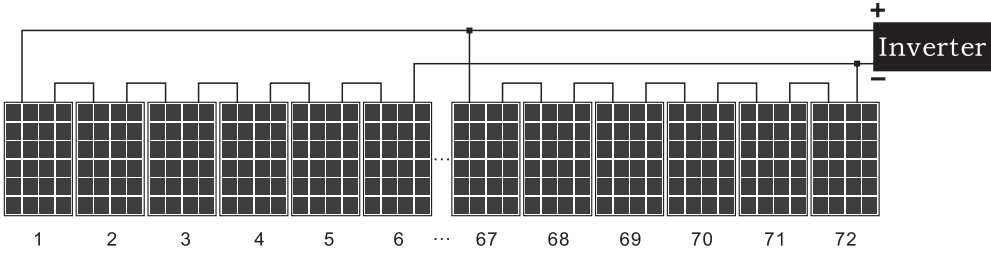

- Daily power generation of solar panels:
 $\text{Power generation} = \text{total solar panel power} \times \text{controller conversion efficiency} \times \text{local sunshine average time}$

